



ADJUSTABLE SHOWERHEAD

D-SHAPED DRAWER PULLS

TASK LIGHTING

DOOR LEVERS

RAISED SOCKET HEIGHT

HomeFitSM Guide

Smart solutions for
making your home comfortable,
safe and a great fit



What if

all homes could be suitable for anyone, regardless of a person's age or physical ability?

What if

a person who wants to live independently, regardless of his or her age or physical ability, could do just that?



The AARP HomeFit Guide was created to help people stay in the home they love by turning where they live into a “lifelong home,” suitable for themselves and anyone in their household. The guide offers solutions that range from simple do-it-yourself fixes to improvements that require skilled expertise.

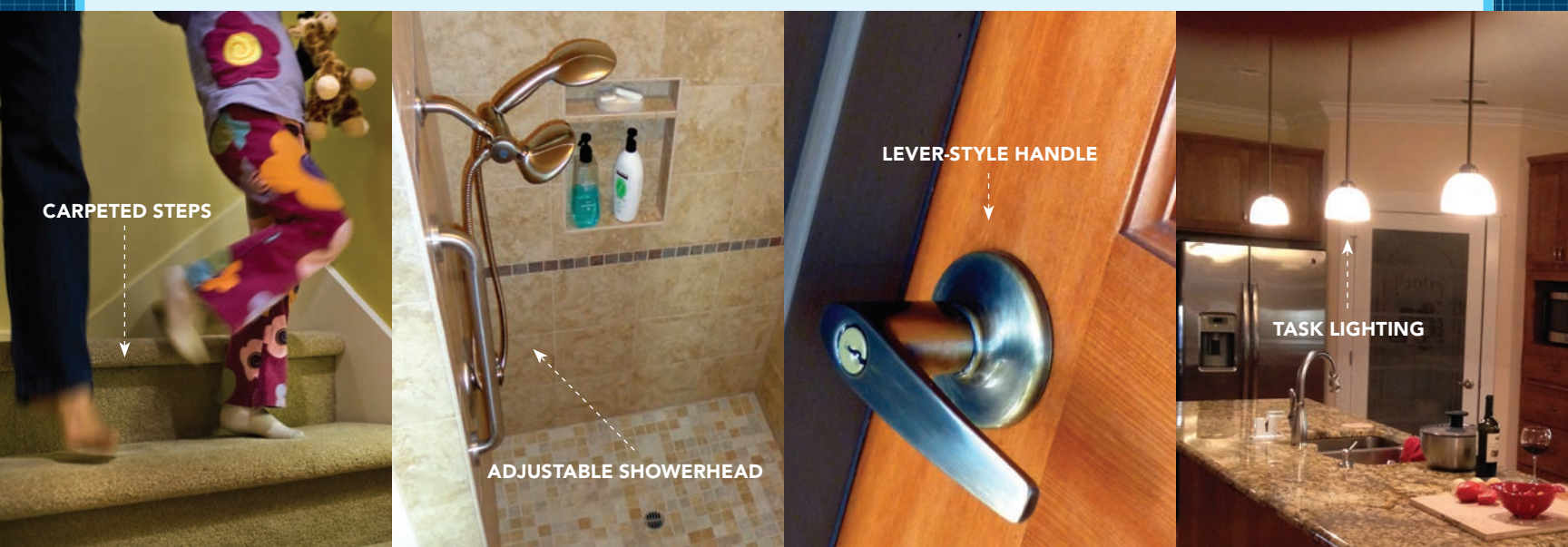

How to use the AARP HomeFit Guide

As both an educational resource and a personalized tool kit, the AARP HomeFit Guide provides lessons, suggestions and practical solutions. The guide is a great resource to keep on your bookshelf or share with friends and family.

Let's get started!

CONTENTS

The Lifelong Home	2
The Room-by-Room HomeFit Tour	4
Home Fitness for Specific Needs	12
Use This, Not That	14
Your HomeFit “To Do” Lists	16
Getting the Right Fit	18
Smart Ways to Spend Less	20
Resources	22
Your Notes	23
Worksheets	24

The Lifelong Home

One way to make a home more livable is to incorporate design principles and products that are adaptable, safe and easy to use. Such smartly designed features are attractive, stylish and come at all price points.

The **AARP HomeFit Guide** will show you how that's possible.

Is Your Home "HomeFit"?

First, let's take a look at where *you* live.

Read the following questions and mark the ones you answer "Yes." (Skip those that don't apply or you're unsure about.) Please don't feel discouraged if you end up responding "No" a lot. The **HomeFit Guide** will explain how simple changes can help you turn those answers to "Yes"!

Is there at least one step-free entrance into your home?

Is there a bedroom, full bathroom and kitchen on the main level?

Are the interior doorways at least 36" wide?

Does your kitchen have a work surface you can use while seated?

Is there a fire extinguisher within reach of the oven or stove?

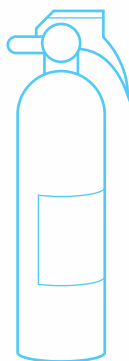

Are your kitchen cabinets and shelves easy for you to reach?

Does your kitchen have a lever-, touch- or sensor-style faucet?

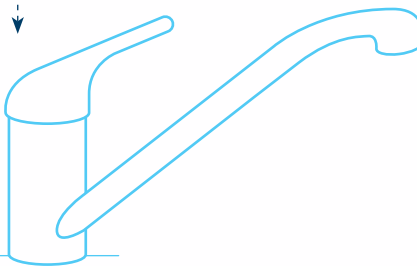

If you use a step stool, does it have nonslip surfaces and a handle you can grip?

Are there secure handrails on both sides of your stairs?

Are your staircases well lighted?

Are your hallways well lighted? (Can you see what's in front of you and on the floor beneath you?)

Are your exterior walkways and entrances well lighted?

Are your exterior walkways free of tripping hazards?

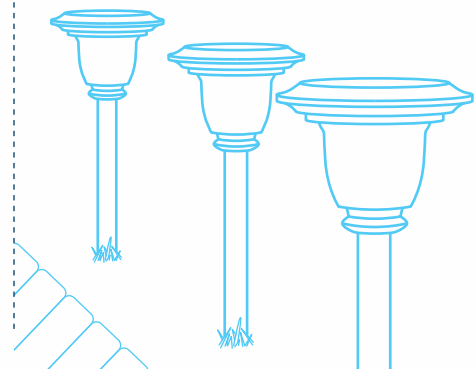

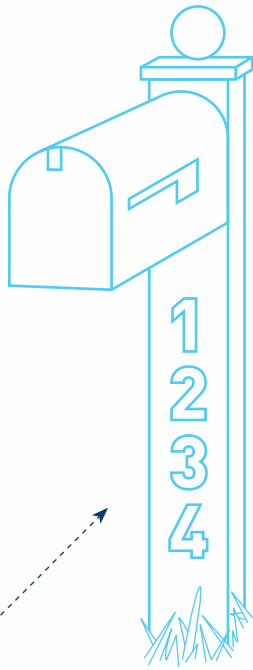

- Is your home's address number clearly visible from the street?
- Is your entrance door easy for you to unlock, lock, open and close?
- Do your exterior doors have secure locks that can't accidentally lock you in or out of the home?
- Does your entrance door have a peephole, viewing panel or security technology so you can see who is outside?
- Does your entrance door have a secure slide latch or chain so you can open the door enough to speak with someone outside while not fully unlocking and opening the door?
- Are the exterior door thresholds easy to see?
- Do all of your area rugs have nonslip grips to prevent tripping or slipping?
- Is the carpeting on your stairs secure and in good condition?

- Are all electrical and phone cords safely located (so they aren't a tripping hazard)?
- Are the switches that control stairway light fixtures located at both the top and bottom of the stairs?

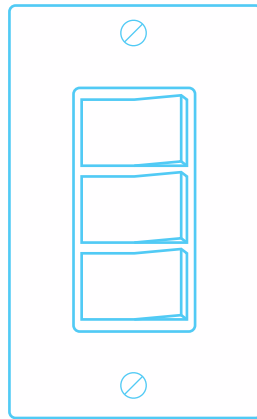

- Do you have a shower with a step-free entry?
- Are the bathroom cabinets and shelves easy for you to reach?
- Does your bathroom have a lever-, touch- or sensor-style faucet?
- Are there nonslip strips or nonslip mats in the bathtub and/or shower?
- Is there "blocking" (e.g., a wood stud or other solid surface) behind the bathroom walls so grab bars can be securely installed in the bathtub, shower and toilet areas?

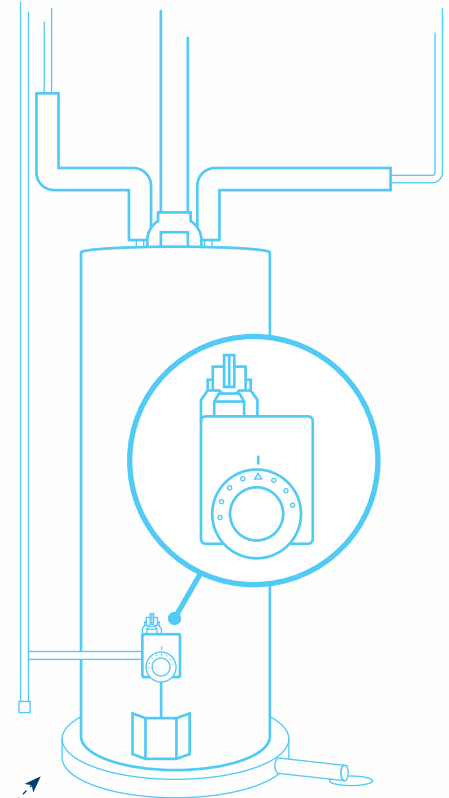
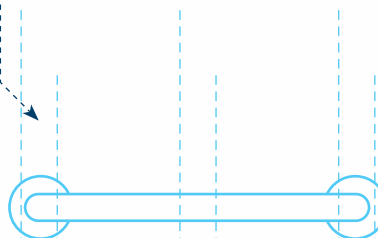

- Is your hot water heater set at or below 120°F?

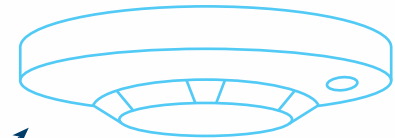

- Are there smoke and carbon monoxide detectors on each floor of the home?
- Can a smoke and carbon monoxide detector be heard in every bedroom?
- Is a telephone easily accessible on every level of your home?
- Do you have flashlights in multiple rooms (in case of a power failure)?

The Room-by-Room HomeFit Tour

Now it's time to learn about the design elements and safety features that help make a home livable for everyone.

In a "HomeFit" home ...

- The address number is visible from the street so emergency responders can locate the home
- Exterior pathways are free of holes, loose bricks, uneven pavement, leaves, moss, mold or other slipping hazards

1234

In a "HomeFit" home ...

- Entrances (inside and out) are free of clutter
- There is a no-trip doorway threshold
- There are handrails on both sides of all steps and stairways

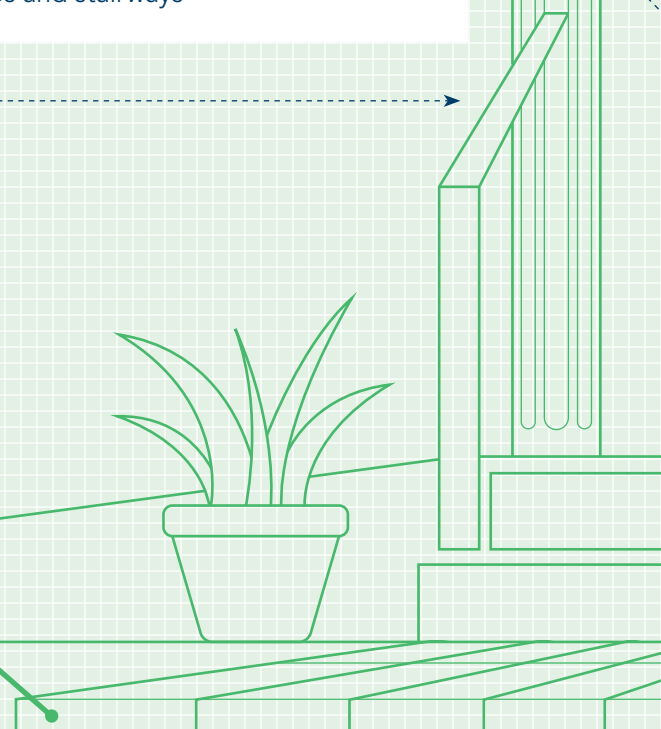
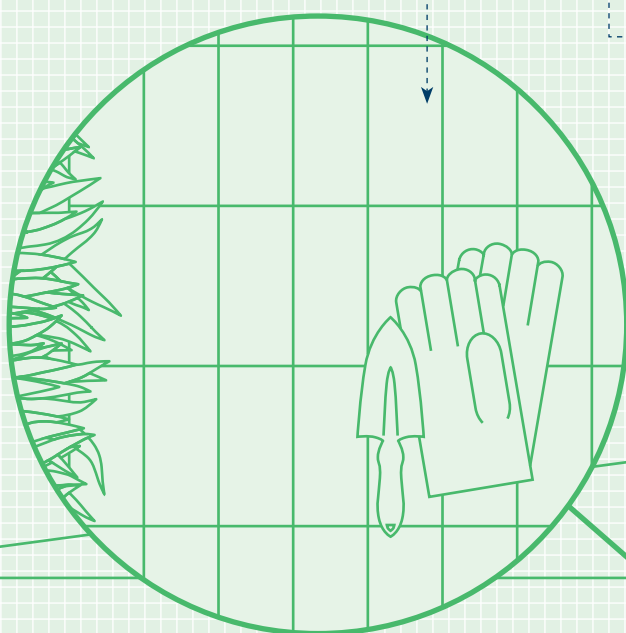

Entrances and Exits

In a "HomeFit" home ...

- Doorways are at least 36" wide, or made that wide by installing swing-away or swing-clear hinges to make use of the entire doorway opening (see page 15 for a picture of the hinges)

In a "HomeFit" home ...

- There is exterior lighting at all entrances
- Outdoor light fixtures have sensors to automatically turn lights on at dusk and off at dawn and/or when motion is detected
- The entrance door has a peephole, viewing panel or security technology for seeing who is outside
- The entrance door has a secure slide latch or chain inside so you can speak to someone outside without fully unlocking and opening the door
- Doors have lever-style handles, which are easier to use than doorknobs

In a "HomeFit" home ...

- There's a bench or table near the entrance door for placing packages while locking or unlocking the door

A Special Message to Renters

Many of the HomeFit Guide's suggestions are doable even if you don't own the house or apartment where you live. For changes that will require some remodeling or installation work, you may need to seek permission from the property owner.

The Kitchen

In a "HomeFit" home ...

- ❑ The cabinetry is easy to access
- ❑ There's pull-out cabinetry or shelves beneath counters and Lazy Susans in corner cabinets

In a "HomeFit" home ...

- ❑ There's suitable task lighting for the sink, stove and other work areas
- ❑ The kitchen has a lever-, touch- or sensor-style faucet rather than one with turn-style knobs or handles
- ❑ The sink faucet is pressure-balanced, temperature-regulated and kept at or below 120°F

In a "HomeFit" home ...

- ❑ The cabinets and drawers have easy-to-grasp D-shaped pulls and handles rather than knobs
- ❑ The floor is not polished with a slippery wax

In a "HomeFit" home ...

- The stove or cooktop controls are near the front of the device so the cook doesn't need to reach over the flame or hot pots. (For the safety of small children who may visit the home, look for controls that can be temporarily locked or removed.)
- The controls for the stovetop are easy to see (by being colored, backlit, etc.)
- The kitchen has a surface where a person can work while seated. (This can be achieved by using a table, installing a pull-out work surface or, sometimes, by removing lower cabinet doors and shelves.)

In a "HomeFit" home ...

- A lightweight, easy-to-use ABC-rated fire extinguisher is in an easy-to-reach place

Steps and Stairways

In a "HomeFit" home ...

- Safe and secure handrails are on both sides of stairs and are placed at a user-appropriate height and properly secured to the walls
- Stairway lights can be turned on and off at both the top and the bottom of the stairs

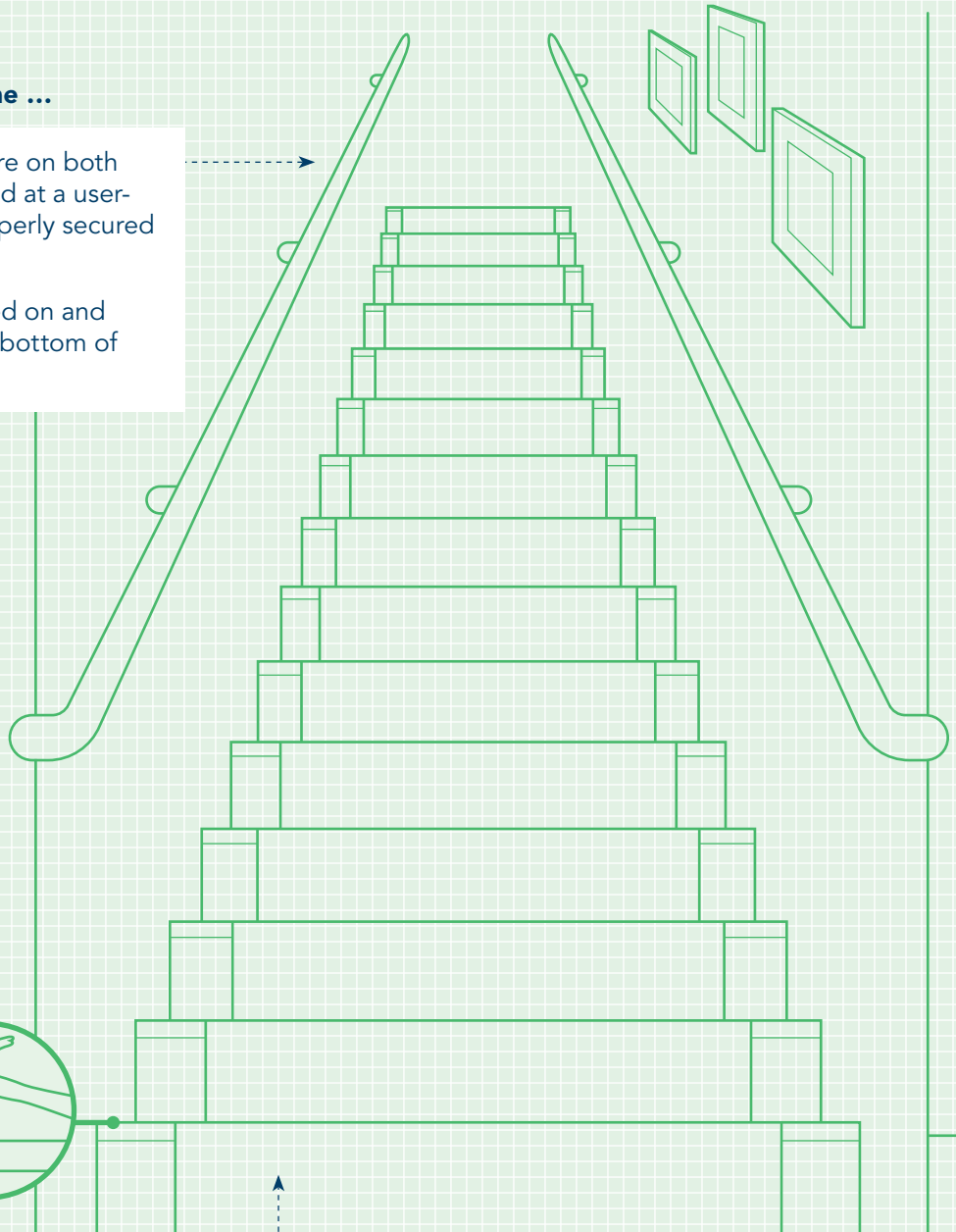

In a "HomeFit" home ...

- Exterior and interior stair treads are in good condition with no weak or missing steps, loose bricks, raised nail heads, open backs, etc.
- Uncarpeted steps feature a nonslip surface such as adhesive strips

In a "HomeFit" home ...

- Automatic night-lights are plugged into outlets near steps and staircases
- All stairs are clear of clutter
- Carpeted steps feature a tightly placed, woven low-pile carpet with thin padding. (If the carpet is patterned, the pattern isn't so busy that it makes the steps difficult to see.)

Living Room and Bedroom

In a "HomeFit" home ...

- Furniture is arranged to allow for clear, wide passageways

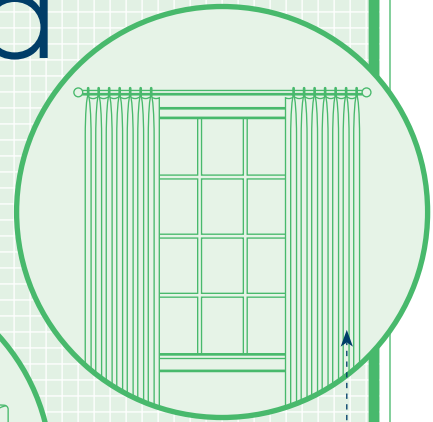
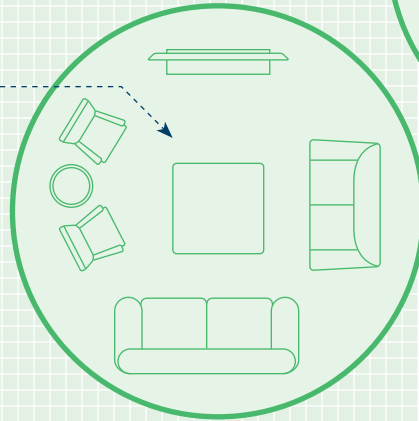

In a "HomeFit" home ...

- Electrical and phone cords are placed out of the way and along the wall to prevent anyone tripping
- Light switches are rocker-style and installed between 36" and 44" from the floor, electrical outlets are placed 18" to 24" from the floor

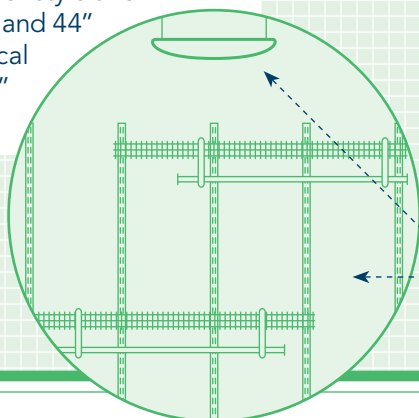

In a "HomeFit" home ...

- The bed is placed in a way that allows easy access to the bathroom
- Large area rugs are secured to the floor with double-sided tape or nonslip mats (and there are no scatter or throw rugs)
- Natural light is used to the fullest by opening curtains, blinds and shades during daylight hours
- Closets have interior lights and adjustable rods and shelves

The Bathroom

In a "HomeFit" home ...

- ❑ The home's water heater has been set at or below 120°F to avoid scalding
- ❑ The toilet is a higher, comfort-height model. (Or maybe there's a toilet seat riser.)
- ❑ Electrical appliances are unplugged when not in use and are never used near a filled sink or tub
- ❑ The sink, bathtub and shower faucets feature easy-to-use lever handles rather than knobs or turn handles

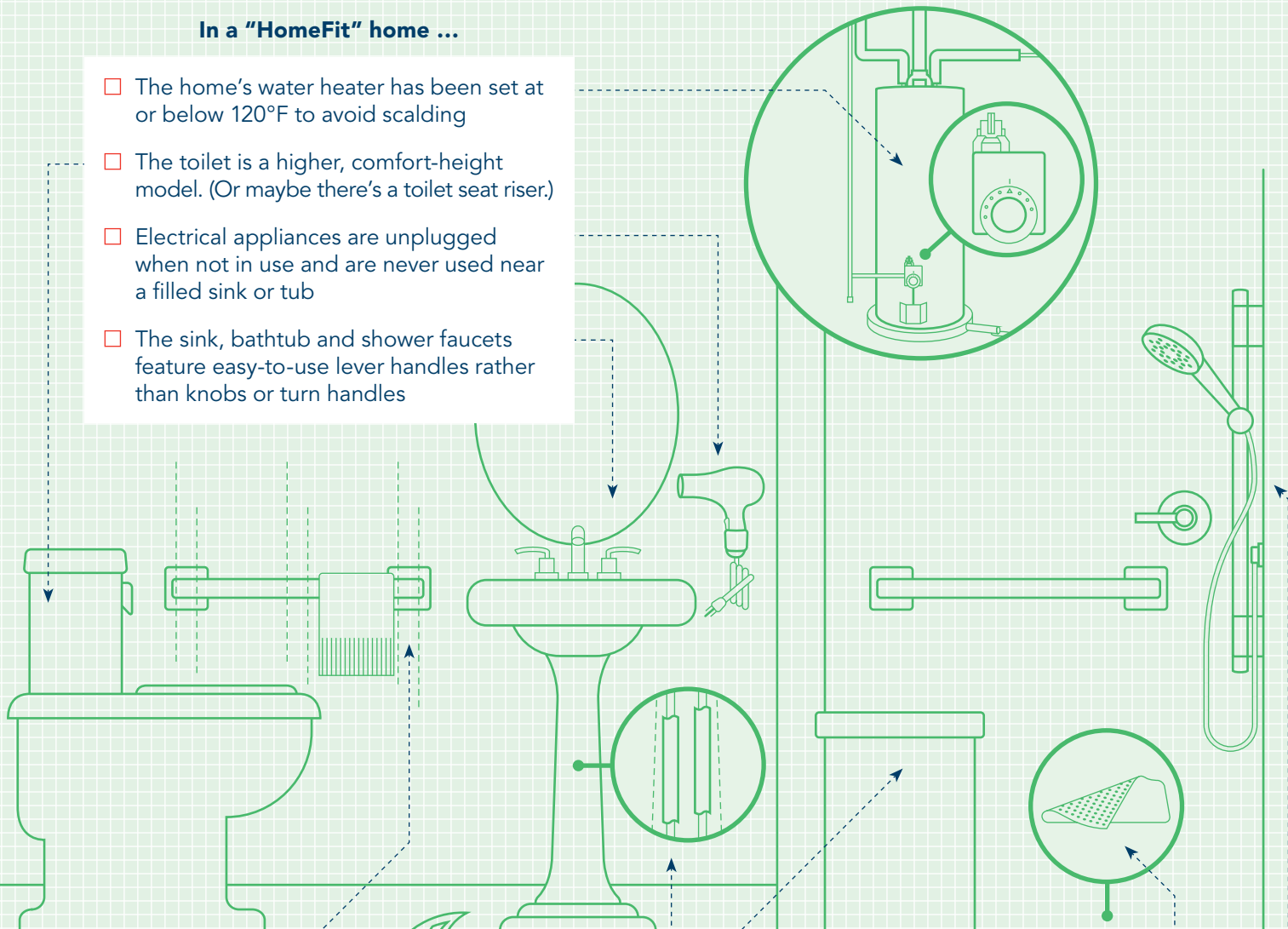

In a "HomeFit" home ...

- ❑ The bathtub and/or shower floor has a nonskid mat or nonslip strips
- ❑ The shower has a no-step entry
- ❑ The shower features a hand-held or adjustable showerhead
- ❑ The shower contains permanent or removable seating in order to bathe while seated
- ❑ Exposed pipes beneath the sink are insulated to protect against touching a hot pipe

In a "HomeFit" home ...

- ❑ The bathroom walls have been reinforced with blocking (e.g., a wood stud or other solid surface) so attractive grab bars can be installed in the bathtub, shower and adjacent to the toilet
- ❑ Any rugs on the bathroom floor are rubber-backed or secured with double-sided rug tape or rubber carpet mesh

Elsewhere and Throughout the Home

In a "HomeFit" home ...

- ❑ Light bulbs are properly rated for the fixtures they are in and are of the highest allowed wattage

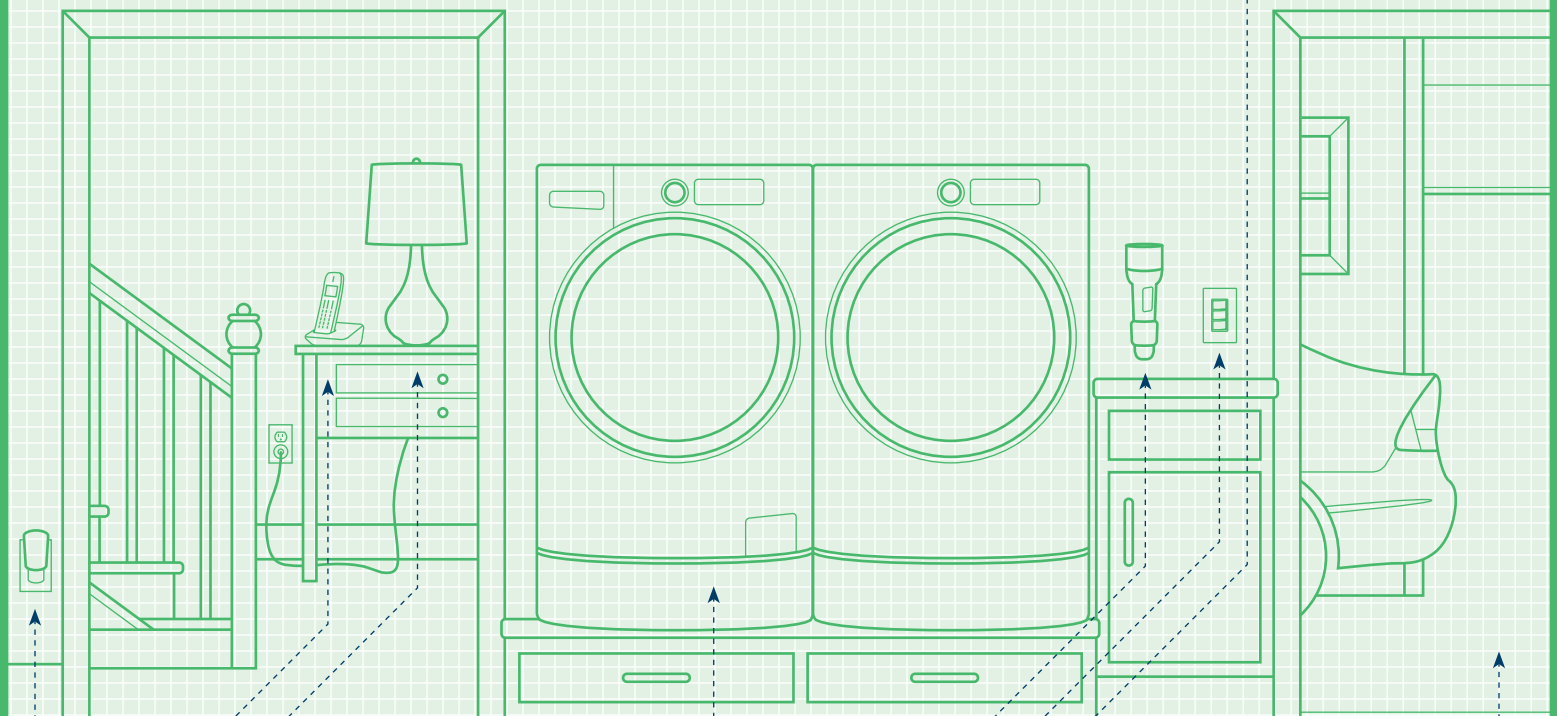
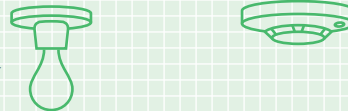

In a "HomeFit" home ...

- ❑ The home contains some touch control lamps and devices that automatically turn lights on and off at set times
- ❑ The laundry area features an easier-to-use front-loading washer, and the washer and dryer sit on raised platforms
- ❑ A telephone is available in or near multiple rooms (including the bedroom and bathroom)
- ❑ Automatic plug-in night-lights are placed in hallways, bathrooms and near steps

In a "HomeFit" home ...

- ❑ Smoke and carbon monoxide detectors are installed on every floor and can be heard in all bedrooms
- ❑ Traditional toggle light switches have been replaced with easier-to-use rocker panel switches
- ❑ Flashlights are kept in multiple rooms (in case of a power failure)
- ❑ There is at least one step-free entrance into the home

Home Fitness for Specific Needs

Simple home modifications can make a home more user-friendly and livable for everyone. Here are just a few examples.

To See More Clearly

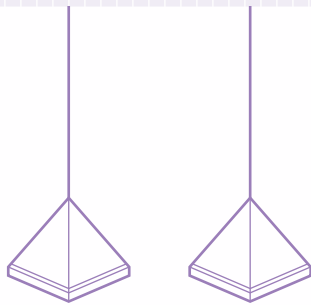

- Install new lights (such as motion-sensor flood lights) or increase lighting on exterior pathways, porches and doorways
- Increase lighting on all stairs, either by plugging night-lights into wall outlets or installing overhead fixtures or wall sconces
- In the kitchen, place lighting over the sink, stove and other work areas and be sure you have a stove with controls that are easy to see
- Keep a magnifying glass in the places you may need one (kitchen, bathroom, living room, bedroom) for reading small print
- Install light switches that glow in the dark
- Place automatic, light-sensor night-lights in hallways and rooms
- Add lighting to closets
- Install a thermostat that's easy to read
- Use full-spectrum bulbs that simulate daylight
- Use halogen bulbs to reduce glare
- Open window shades, blinds and curtains for natural light during the day

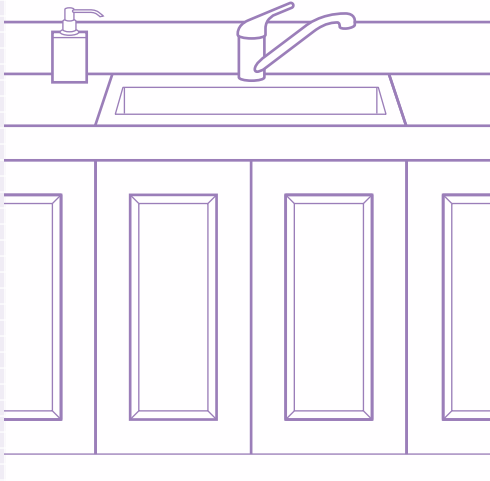

Help is Available

An occupational therapist (OT) or Certified Aging-in-Place Specialist (CAPS) can visit your home, assess your needs and recommend helpful home modifications. See page 18.

To More Easily Reach and Move All About

- Use adjustable and low rods and shelves in closets and cabinets. Consider pull-out or pull-down shelves, or drawers designed to close automatically
- Have the dishwasher elevated to reduce the amount of bending you must do
- Choose a side-by-side or drawer-style refrigerator
- Sit rather than stand while working at the kitchen countertop. (If necessary, have cabinet shelves or drawers removed to allow room for your knees.)
- Buy touch control lamps or "clapper" devices for lights and electronics
- Install a walk-in or no-threshold shower, a bath seat or bench and an adjustable, hand-held showerhead
- Use a front-loading washer, and place the washer, dryer, shelves and work surfaces at reachable heights
- Keep a cell phone on you, or install a telephone in multiple rooms (including the bathroom) so you're never too far from being able to call for help

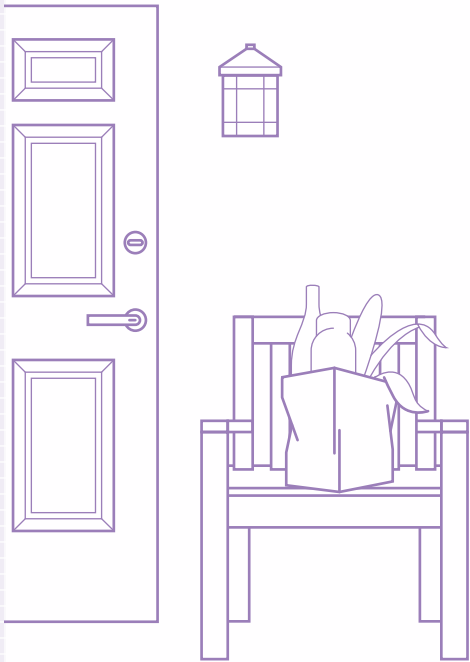

To Lend Your Hands a Helping Hand

- Replace round doorknobs with easier-to-use lever-style door handles
- Put a chair or table near the entrance door for placing packages while you lock or unlock the door
- Replace traditional toggle-style light switches with larger, easier-to-use rocker-style light switches
- Repair or replace any hard-to-open windows



Use This, Not That

Create a shopping list and bring the list (or this entire guide) to the store.

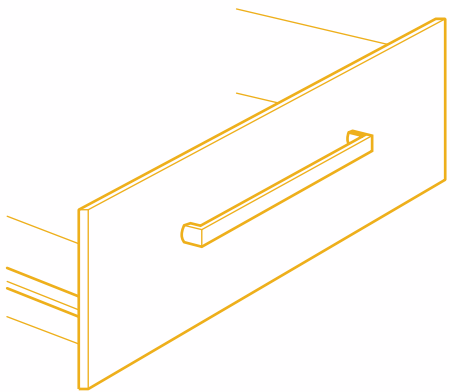

- **Use D-shaped handles, not round cabinet knobs**

Because D-shaped handles are easier to grip

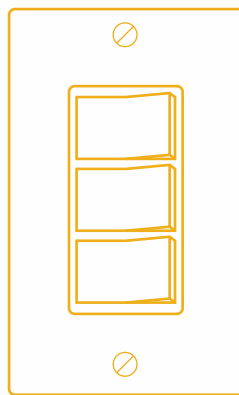

- **Use rocker-style wall switches, not toggle wall switches**

Because a rocker-style "push" switch is easier for everyone to use than an up-and-down "flip" switch



- **Use lever handles, not round doorknobs or thumb-push handles**

Because lever handles are easier to manage, even when your hands are full

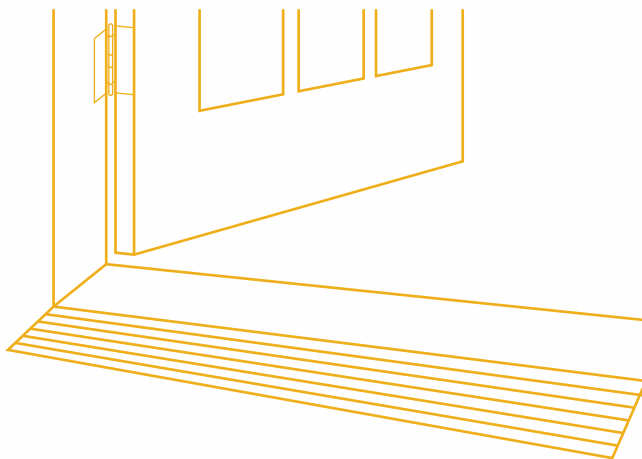

- **Use a no-step or compressible rubber threshold, not a raised or hard threshold**

Because a no-step or zero-step entry into the home lessens tripping hazards and allows easier access for wheelchairs and strollers

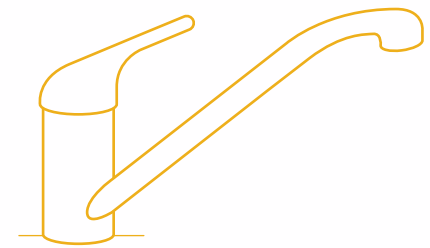

- **Use lever-, touch- or sensor-style faucets, not round turn handles or knobs**

Because round handles or knobs can be difficult to grip

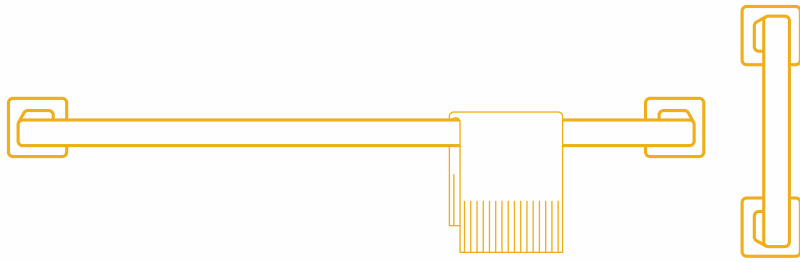

- ❑ **Use grab bars that are securely installed to a solid wall surface, not towel bars or suction cup grab bars**

Because bars identified and sold as grab bars are sturdy and can be decorative, while suction cup grab bars often fall off walls, and towel bars aren't intended to support a lot of weight

1 2 3 4

- ❑ **Use address numbers that are easy to see, not hidden or dark numbers**

Because you want emergency responders to be able to find your home

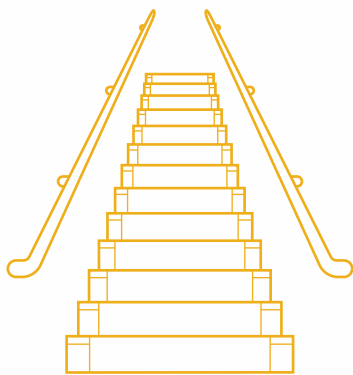

- ❑ **Use railings on both sides of staircases, not a single railing or (yikes!) no railing**

Because railings can prevent falls and provide support that everyone can use when climbing up or going down stairs

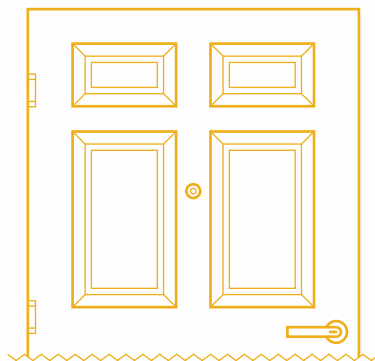

- ❑ **Use a door that has a peephole or viewing panel, not a solid door**

Because you want to be able to see who is at the door before you open it

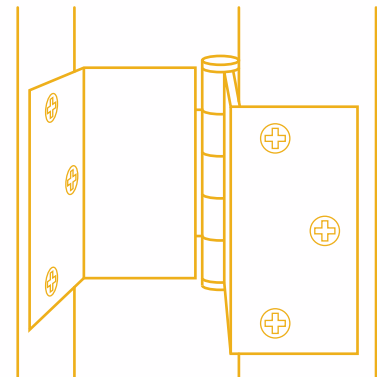

- ❑ **Use a wide door (or a door with swing-away or swing-clear hinges) to provide a 36" wide entrance, not a narrow door**

Because wide doors are useful if you have mobility constraints — and they're great when moving furniture!



- ❑ **Use an adjustable showerhead, not a stationary showerhead**

Because an adjustable showerhead can be used when seated or standing

- ❑ **Use a microwave oven placed at the countertop level, not overhead**

Because overhead microwave ovens can be difficult to reach

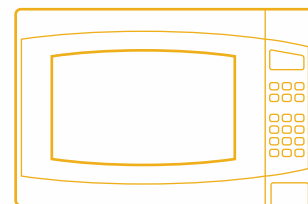

More Smart Selections

While you're shopping, pick up some:

- ❑ Automatic night-lights for hallways and bathrooms
- ❑ Screw-in dusk-to-dawn sensors for outdoor light fixtures
- ❑ Nonslip bath mats for the tub or shower as well as for the bathroom floor

Your HomeFit "To Do" Lists

Some HomeFit improvements are so simple they can take seconds to complete — and you really can do them yourself. Other projects require both skill and time.

The Do-It-Yourself List

You'll likely be able to handle all or some of the following tasks. If in doubt about your abilities, seek the help of a family member, friend or skilled professional.

- Install night-lights in the bathroom and in the hallways that are used after dark
- Apply nonslip adhesive strips to uncarpeted stair treads
- Remove all scatter rugs or use double-sided tape to secure them to the floor
- Install a rubber-suction bathmat or anti-slip floor strips or decals in the tub and shower
- Place a lightweight, easy-to-use ABC-rated fire extinguisher in an easily accessible location in the kitchen
- Arrange furniture to allow for easy passage
- Check the carpeting on stairs to be sure it's firmly attached
- Set the hot water heater to 120°F or below to reduce energy costs and prevent scalding
- Install address numbers that can be easily seen from the street
- Install lever-style door handles, which are easier to use than doorknobs
- Keep a phone near your bed and in the rooms you spend a lot of time. (If you use a corded phone, take care to avoid tripping over the cord.)
- Install a hand-held, adjustable-height showerhead for easier bathing
- Check the wattage ratings on your lamps and light fixtures, and install the brightest bulbs allowed
- Place electrical and phone cords along a wall where they won't be a tripping hazard
- Install smoke and carbon monoxide detectors on all levels of the house, especially in or near the bedrooms
- Replace knobs on cabinets and drawers with easier-to-grip D-shaped handles
- Add a work surface you can sit at by placing a table where needed, or by removing some cabinet doors and shelving beneath a countertop
- Check outdoor walkways for loose bricks or pavers, and keep the paths clear of debris, including slippery wet leaves, moss or mold
- Trim overgrown shrubbery to provide a clear view from doors and windows
- Create an emergency exit plan for getting yourself and others out of the home

The *Don't-Do-It Yourself* List

For certain improvements you may need to hire a skilled contractor or seek help from a handy friend or relative. Some examples:

- Replace traditional light switches with easier-to-use rocker-style light switches
- Install a handrail on both sides of any staircase
- Mount grab bars next to the toilet and bathtub and in the shower
- Install swing-away or swing-clear hinges on all doors to add two inches of width for easier access
- Install a security peephole on exterior doors
- Install deadbolts and other protective hardware on exterior doors
- Install photosensitive porch or entryway lighting that will turn on at dusk and off at dawn
- Install outdoor floodlights with motion sensors
- Replace or remove any worn, torn or loose carpeting
- Install adjustable, pull-down shelving to facilitate safe access to upper cabinets
- Install a Lazy Susan in corner cabinets and pull-out cabinetry or shelving under counters
- Insulate the attic for better heating and cooling energy efficiency

When Hiring a Home Improvement Contractor

1. Make a list of what you need done

Write down *exactly* what you want the contractor to do.

2. Seek recommendations from family and friends

Beware the stranger who shows up at your home unannounced and says something like, "I'm on a job in the area already so I can give you a good price." This is rarely a smart choice and could be a scam. (Visit aarp.org/fraudwatch for more about protecting yourself from scammers.)

3. Check the recommendations

The Better Business Bureau (visit bbb.org) can tell you if complaints have been filed against a contractor or company. Also, although having a state license doesn't guarantee reliability, it's a minimum qualification a contractor should have.

4. Ask for estimates

Meet with at least three contractors. Estimates should detail the materials to be used, the labor charges, the start and end dates and the total cost. Ask for proof that the contractor is licensed, bonded and covered by workers' compensation and liability insurance. Check references from past clients.

5. Get everything in writing

Don't approve any plans you don't understand. Never sign a contract with any blanks, and do keep a copy of everything you sign. Take your time to make a decision and, remember, genuinely good deals will still be there tomorrow.

6. Don't pay the final bill until all the work is complete

Be sure all required building authorities have inspected the work, and get a written statement that the contractor has paid all of the subcontractors and suppliers.

Getting the Right Fit

It can be hard to know which furnishings and housing features provide the best comfort, safety and ease of use. For those reasons and others, it may be useful to bring in an **Occupational Therapist** or **Certified Aging-in-Place Specialist**.

What's a "CAPS"?

The National Association of Home Builders (NAHB), in collaboration with AARP and other experts, developed the Certified Aging-in-Place Specialist (CAPS) designation, which is achieved through training and testing during a multicourse educational program.

A Certified Aging-in-Place Specialist understands the unique needs of the older adult population and is knowledgeable about aging-in-place home modifications, common remodeling projects and solutions to common barriers. CAPS designees are often remodelers, but designers, OTs, architects and others frequently achieve this designation as well.

CAPS remodelers and design-build professionals are not medical or health care providers. They are generally paid by the hour or receive a flat fee per visit or project. To find a Certified Aging-in-Place Specialist in your area call the NAHB at 800-368-5242 or visit its directory page "Find a Certified Aging-in-Place Specialist" at nabh.org.

A Certified Aging-in-Place Specialist can:

- Recommend updates that will help a person live independently in his or her own home
- Work with an OT to develop a home modification or build plan based on the safety and functional needs of an individual or household
- Collaborate with a licensed contractor or interior designer about building and design strategies and techniques for creating attractive, barrier-free living spaces
- Provide information about building codes and standards, useful products and resources, and the costs and time required for common remodeling projects

What's an "OT"?

Occupational therapists (OTs) are licensed health care professionals who understand the health and disability issues people face over a lifetime and know how to match the abilities of an individual with needed supports.

OTs are skilled at performing home assessments that identify a person's daily routines and activities and the barriers that impact performing them. An OT then works with the individual, the family and others to identify solutions for achieving the desired goals.

An OT has a strong understanding of how an individual functions in her or his space, which is essential for making recommendations that will enhance function and safety in the home environment. This person-centered focus helps ensure that any modifications made to a home will meet both current and future needs. Such assessments save money in the long run by helping to avoid mistakes in product selections and design solutions.

All OTs have training in basic home assessments, and some have additional training or certifications including Specialty Certification in Environmental Modification (SCEM) through the American Occupational Therapy Association (aota.org), the Executive Certificate in Home Modification (ECHM) or the CAPS designation.

Occupational therapists are generally paid a flat fee per visit and their services may be covered by health insurance. (Check with your insurance provider.) To learn more about occupational therapists, visit aota.org. To find an OT in your area, check with your physician, health insurance provider or local hospital or seek recommendations from family and friends, or even age-friendly builders.



An Occupational Therapist can:

- Assess an individual's abilities, challenges and needs. (This is often done by asking questions, such as: Do you have medical conditions that impact your daily life? What activities are painful or difficult for you to do?)
- Provide a home evaluation and recommend changes to increase safety and ease of use
- Identify furnishings, equipment and techniques that can help with regular or needed activities
- Suggest and demonstrate techniques that can make essential activities possible or easier
- Collaborate with a home improvement contractor to develop a modification or build plan that will meet the needs of an individual or household
- Work with clients after the modifications, equipment or specialized products have been installed in order to ensure safe usage

Smart Ways to Spend Less

After a mortgage, utility bills for heating and cooling are among the priciest expenses of maintaining a residence. Here are 22 ways to lower those costs.

Let the Sun Shine In (Sometimes)

- Open curtains, blinds or shades on south-facing windows in winter to let the sun warm your rooms. In summer, close the window coverings to keep rooms cool.
- If you live in a warm climate, install white shades or blinds on windows to reflect heat away from the house.
- To block solar heat and protect furnishings from UV damage, install awnings over windows if the roof eaves or other overhangs don't shield windows from direct sunlight.

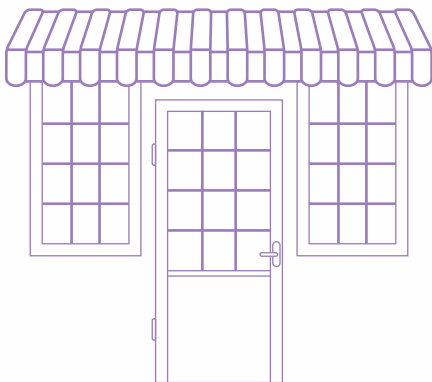

Hot and Cold

- Install glass doors on a fireplace opening to prevent embers and ash from flying free and keep the warm air in the house from escaping up the chimney. Shut the fireplace damper when the fireplace is not in use to prevent heated air from going up the chimney. After burning a fire, be sure all embers are out before closing the damper.
- Turn ceiling fans on low, and set the blades to force warm air near the ceiling downward in the winter. Do the reverse in the summer by making the blades turn in the opposite direction.
- Use heat-generating appliances such as clothes dryers and ovens during the coolest time of day. This reduces the load on your air conditioner in the summer and helps heat the house in the winter.
- Install a programmable thermostat to change the set point for heating and cooling when you are away from home or are asleep.
- Install weather stripping or caulk around doors and windows, and place foam gaskets behind outlet plate covers on exterior walls. If there's a gap at the bottom of the door, install a door sweep or door shoe gasket.
- Remove window air-conditioning units before cold weather to prevent heat from escaping through and around the unit. If the a/c unit can't be removed, cover it to prevent drafts and air leaks.
- Insulate the attic to maximize energy efficiency and save on both heating and cooling costs.
- Unsealed or improperly insulated ducts running through unfinished spaces — such as attics, crawl spaces and garages — waste energy. Seal the joints with a non-hardening sealant and insulate the ducts. Use expanding foam, which comes in convenient aerosol cans, to seal gaps around pipes that connect from the outdoors.

Power-Friendly Ideas

- ❑ Shut off lights in unoccupied rooms, and turn off kitchen and bathroom ventilating fans after they've done their job.
- ❑ Unplug chargers — such as phone, computer and small appliance chargers — when not in use. If the charger is plugged into the wall, it's still on and consuming energy even if you aren't charging.
- ❑ Air dry dishes and cookware instead of using the dishwasher's drying cycle.
- ❑ Install a motion detector or photocell unit on exterior lights so they'll turn on only when needed and will automatically turn off during the day.

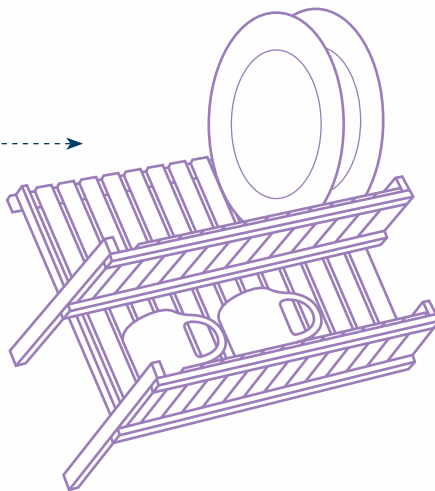

- ❑ To identify ways your home is wasting energy, ask your utility company to do an energy audit. Cost for an audit varies, but some companies do offer free audits and/or provide free items, such as high-efficiency light bulbs and water-saving showerheads.

Clean and Save

- ❑ For maximum heating and cooling output, regularly clean HVAC air vents and registers or baseboard heaters and radiators. Have heating and air-conditioning systems professionally checked once a year. (Two more tips: Push warmth into a room by placing a heat-resistant reflector between the radiator and the outside wall. Ensure all vents are providing heat and cool air by keeping all vents and outputs clear of curtains, furniture and carpeting.)
- ❑ Replace or clean furnace air filters every 30 to 90 days according to the furnace or filter manufacturer's instructions. Dirty filters block airflow, which forces a furnace or HVAC system to run longer, raising your energy bill.

Water Works

- ❑ To reduce your water consumption and heating costs, take showers instead of baths, install a water-saving showerhead and set the hot water heater at 120°F or below.
- ❑ Run washing machines and dishwashers only when you have full loads. When suitable, use the cold water setting on your clothes washer to reduce water-heating costs.
- ❑ Wrap your hot water heater with an insulation blanket or jacket. (Note: Blankets aren't recommended for gas heaters and those with automatic vent dampers. Check with the manufacturer to see if your unit can be wrapped.)

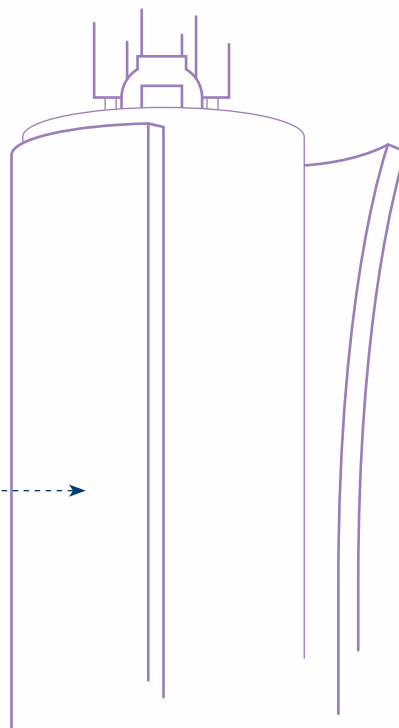

- ❑ Clean the lint filter in your clothes dryer after every load, and periodically clean the dryer's vent system. Lint buildup in the filter can cause the dryer to run longer, which wastes energy. (Also, excess lint in the filter and vent can be a fire hazard.)

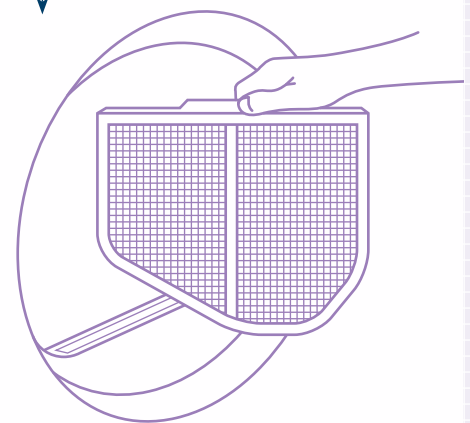

Resources

These websites feature information about many of the topics addressed in this guide.

AARP Livable Communities

The AARP HomeFit Guide was created by the AARP Livable Communities team, whose website houses an online version of this guide and accompanying worksheets at aarp.org/homefit. The site also contains information about how communities nationwide can become more livable for older adults and people of all ages. The page aarp.org/agefriendly includes resources for community leaders. (If you want to get in touch, email us at livable@aarp.org.)

aarp.org/livable

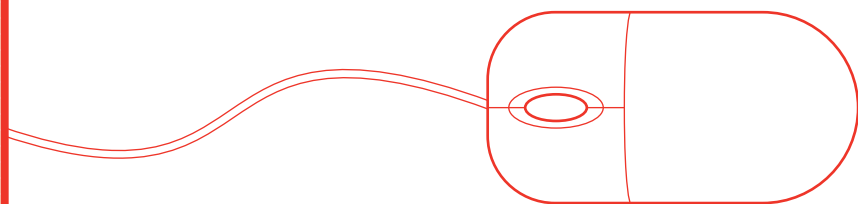

American Occupational Therapy Association

Although the AOTA is a professional association for occupational therapists, assistants and students, the website's "Patients and Clients" section provides information for consumers.

aota.org

National Association of Home Builders

A trade association for the home construction industry, the NAHB administers the "Certified Aging-in-Place" program (see page 18). The website contains consumer-oriented home-ownership and home remodeling information.

nahb.org

Your Notes

Worksheets

AARP HomeFit's free worksheets can help you put into place the ideas discussed in the AARP HomeFit Guide. Select the worksheets you want — or use them all!

- Is My Home "HomeFit"?
- My Room-by-Room Do-It-Myself List
- My Contractor Reference Check Notes
- My Room-by-Room HomeFit List
- My Room-by-Room Don't Do-It-Myself List
- My Home Maintenance Schedule
- My Room-by-Room Shopping List
- My Contractor Interview Notes
- My Emergency Contacts



If you're attending an AARP HomeFit Workshop in person, the worksheets are housed in the pocket at right.

The AARP HomeFit Guide and worksheets are also available for order by calling 888-OUR-AARP or visiting aarp.org/livable-communities/publications.

In addition, you can read and download the AARP HomeFit Guide and the worksheets at aarp.org/homefit.



ENTRY LIGHTING



ELEVATED FRONT-LOAD
WASHER/DRYER



GRAB BAR



PULL-OUT CABINETS



The AARP HomeFit Guide is a publication of AARP Education & Outreach/Livable Communities

aarp.org/livable



To attend an AARP HomeFit Workshop, contact the AARP office for your state by visiting aarp.org/states or calling 888-OUR-AARP



To read the AARP HomeFit Guide online or order additional copies visit AARP.org/homefit



Share your HomeFit tips, photos and stories by emailing us at livable@AARP.org



Learn more about AARP Livable Communities at AARP.org/livable or by following us on Twitter [@LivableCmnty](https://twitter.com/LivableCmnty)



601 E Street NW, Washington, D.C., 20049